

COMPLEX TRANSISTOR ARRAY FOR BIPOLAR TRANSISTOR HALF H-BRIDGE MOTOR/ACTUATOR DRIVER
Features

- Epitaxial Planar Die Construction
- **Lead Free By Design/RoHS Compliant (Note 1)**
- **"Green" Device (Note 2)**

Sub-Component P/N	Reference	Device Type
MMBT2907A_DIE	Q1	PNP Transistor
MMBTA06_DIE	Q2	NPN Transistor



Top View

Mechanical Data

- Case: SOT-363
- Case Material: Molded Plastic, "Green" Molding Compound. UL Flammability Classification Rating 94V-0
- Moisture Sensitivity: Level 1 per J-STD-020D
- Terminal Connections: See Schematic & Pin Configuration
- Terminals: Finish - Matte Tin annealed over Alloy 42 leadframe. Solderable per MIL-STD-202, Method 208
- Marking Information: See Page 6
- Ordering Information: See Page 6
- Weight: 0.016 grams (approximate)

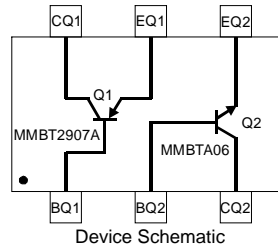

Device Schematic

Maximum Ratings: Total Device @ $T_A = 25^\circ\text{C}$ unless otherwise specified

Characteristic	Symbol	Value	Unit
Operating and Storage Junction Temperature Range	V_{EBO}	-55 to +150	$^\circ\text{C}$

Thermal Characteristics: Total Device

Characteristic	Symbol	Value	Unit
Power Dissipation (Note 3)	P_D	200	mW
Thermal Resistance, Junction to Ambient Air (Note 3)	$R_{\theta JA}$	625	$^\circ\text{C/W}$

Maximum Ratings: Sub-Component Devices @ $T_A = 25^\circ\text{C}$ unless otherwise specified

Characteristic	Symbol	Q1-PNP Transistor (MMBT2907A)	Q2-NPN Transistor (MMBTA06)	Unit
Collector-Base Voltage	V_{CBO}	-60	80	V
Collector-Emitter Voltage	V_{CEO}	-60	65	V
Emitter-Base Voltage	V_{EBO}	-5.5	6	V
Collector Current - Continuous (Note 3)	I_C	-600	500	mA

- Notes:
1. No purposefully added lead.
 2. Diodes Inc.'s "Green" policy can be found on our website at http://www.diodes.com/products/lead_free/index.php.
 3. Device mounted on FR-4 PCB, 1 inch x 0.85 inch x 0.062 inch; pad layout as shown on page 7 or on Diodes Inc. suggested pad layout document AP02001, which can be found on our website at <http://www.diodes.com/datasheets/ap02001.pdf>.

Electrical Characteristics: PNP (MMBT2907A) Transistor (Q1) @_{T_A} = 25°C unless otherwise specified

Characteristic	Symbol	Min	Max	Unit	Test Condition
OFF CHARACTERISTICS (Note 4)					
Collector-Base Breakdown Voltage	$V_{(BR)CBO}$	-60	—	V	$I_C = -10\mu A, I_E = 0$
Collector-Emitter Breakdown Voltage	$V_{(BR)CEO}$	-60	—	V	$I_C = -10mA, I_B = 0$
Emitter-Base Breakdown Voltage	$V_{(BR)EBO}$	-5.5	—	V	$I_E = -10\mu A, I_C = 0$
Collector Cutoff Current	I_{CBO}	—	-10	nA	$V_{CB} = -50V, I_E = 0$
Collector Cutoff Current	I_{CEX}	—	-50	nA	$V_{CE} = -30V, V_{EB(OFF)} = -0.5V$
Base Cutoff Current	I_{BL}	—	-50	nA	$V_{CE} = -30V, V_{EB(OFF)} = -0.5V$
ON CHARACTERISTICS (Note 4)					
DC Current Gain	h_{FE}	100	—	—	$I_C = -100\mu A, V_{CE} = -10V$
		100	—	—	$I_C = -1.0mA, V_{CE} = -10V$
		100	—	—	$I_C = -10mA, V_{CE} = -10V$
		100	300	—	$I_C = -150mA, V_{CE} = -10V$
		50	—	—	$I_C = -500mA, V_{CE} = -10V$
Collector-Emitter Saturation Voltage	$V_{CE(SAT)}$	—	-0.3 -0.5	V	$I_C = -150mA, I_B = -15mA$ $I_C = -500mA, I_B = -50mA$
Base-Emitter Saturation Voltage	$V_{BE(SAT)}$	—	-0.95 -1.3	V	$I_C = -150mA, I_B = -15mA$ $I_C = -500mA, I_B = -50mA$
SMALL SIGNAL CHARACTERISTICS					
Current Gain-Bandwidth Product	f_T	100	—	MHz	$V_{CE} = -2.0V, I_C = -10mA,$ $f = 100MHz$
SWITCHING CHARACTERISTICS					
Turn-On Time	t_{on}	—	45	ns	$V_{CE} = -30V, I_C = -150mA,$ $I_{B1} = -15mA$
Delay Time	t_d	—	10	ns	
Rise Time	t_r	—	40	ns	
Turn-Off Time	t_{off}	—	100	ns	$V_{CC} = -6.0V, I_C = -150mA,$ $I_{B1} = I_{B2} = -15mA$
Storage Time	t_s	—	80	ns	
Fall Time	t_f	—	30	ns	

Electrical Characteristics: NPN (MMBTA06) Transistor (Q2) @_{T_A} = 25°C unless otherwise specified

Characteristic	Symbol	Min	Typ	Max	Unit	Test Condition
OFF CHARACTERISTICS (Note 4)						
Collector-Base Breakdown Voltage	$V_{(BR)CBO}$	80	—	—	V	$I_C = 100\mu A, I_E = 0$
Collector-Emitter Breakdown Voltage	$V_{(BR)CEO}$	65	—	—	V	$I_C = 1mA, I_B = 0$
Emitter-Base Breakdown Voltage	$V_{(BR)EBO}$	6	—	—	V	$I_E = 100\mu A, I_C = 0$
Collector-Base Cutoff Current	I_{CBO}	—	—	100	nA	$V_{CB} = 80V, I_E = 0$
Collector Cutoff Current	I_{CES}	—	—	100	nA	$V_{CE} = 90V, V_{BE} = 0$
Emitter-Base Cutoff Current	I_{EBO}	—	—	100	nA	$V_{EB} = 5V, I_C = 0$
ON CHARACTERISTICS (Note 4)						
DC Current Gain	h_{FE}	250	—	—	—	$V_{CE} = 1V, I_C = 10mA$
		100	—	—	—	$V_{CE} = 1V, I_C = 100mA$
Collector-Emitter Saturation Voltage	$V_{CE(SAT)}$	—	0.2	0.4	V	$I_C = 100mA, I_B = 10mA$
Base-Emitter Turn-on Voltage	$V_{BE(ON)}$	0.7	0.75	0.8	V	$V_{CE} = 1V, I_C = 100mA$
Base-Emitter Saturation Voltage	$V_{BE(SAT)}$	—	—	0.95	V	$I_C = 100mA, I_B = 5mA$
SMALL SIGNAL CHARACTERISTICS						
Current Gain-Bandwidth Product	f_T	100	—	—	MHz	$V_{CE} = 20V, I_C = 10mA,$ $f = 100MHz$

Notes: 4. Short duration pulse test used to minimize self-heating effect.

Typical Characteristics @ $T_A = 25^\circ\text{C}$ unless otherwise specified

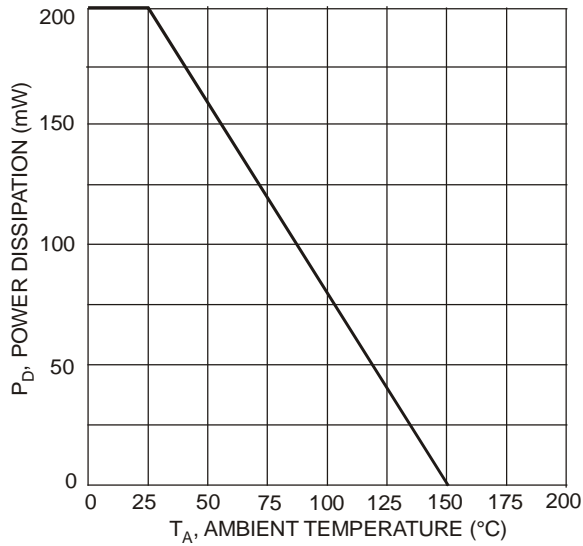

Fig. 1 Power Derating Curve

PNP (MMBT2907A) Transistor (Q1) Plots:

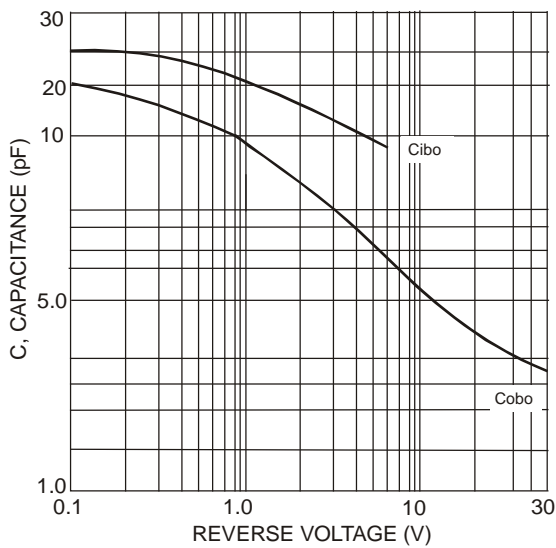

Fig. 2 Typical Capacitance

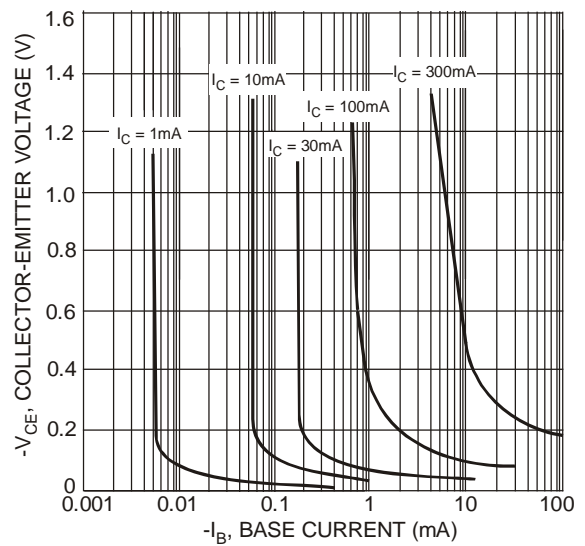

Fig. 3 Typical Collector Saturation Region

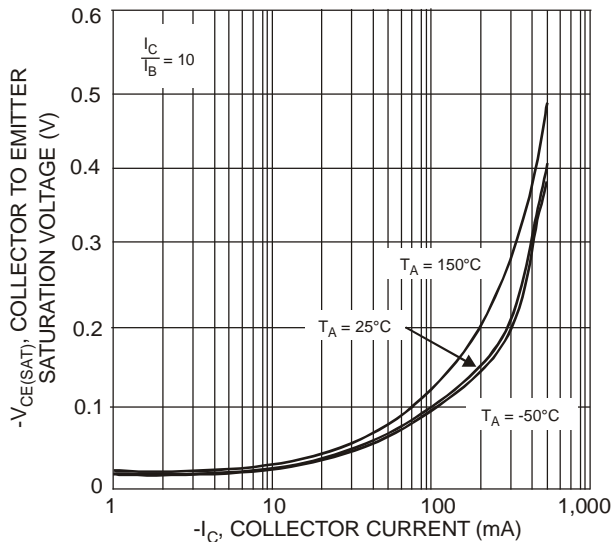

Fig. 4 Collector Emitter Saturation Voltage vs. Collector Current

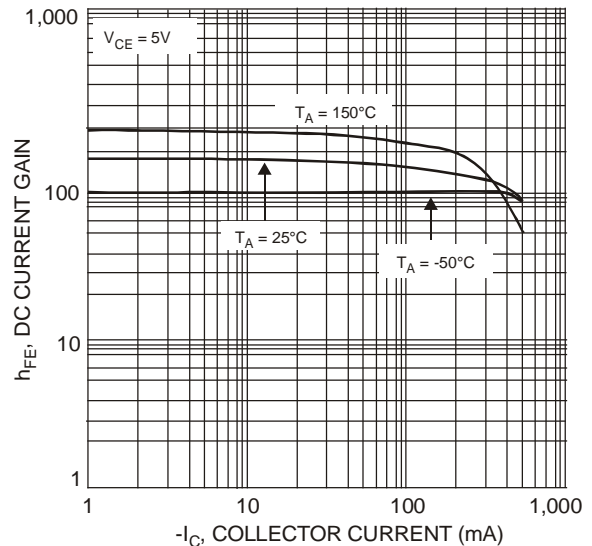

Fig. 5 Typical DC Current Gain vs. Collector Current

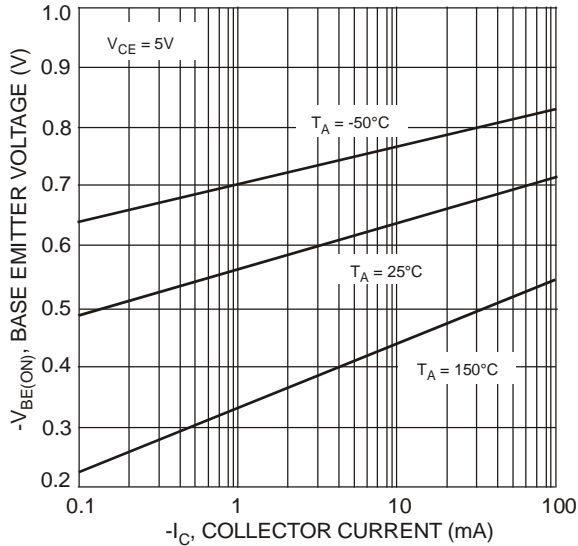

Fig. 6 Typical Base Emitter Voltage vs. Collector Current

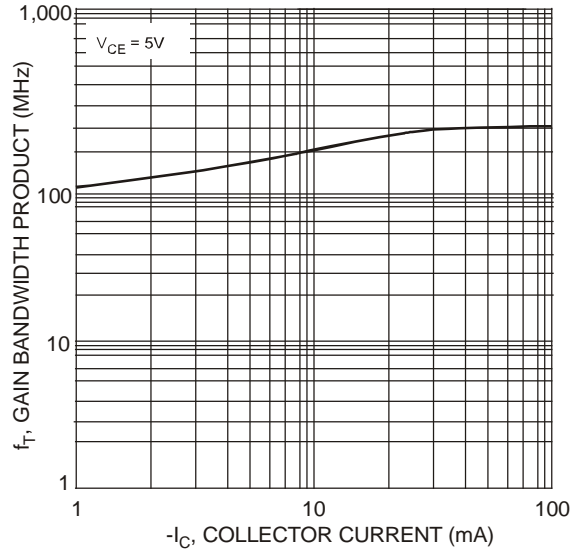

Fig. 7 Typical Gain Bandwidth Product vs. Collector Current

NPN (MMBTA06) Transistor (Q2) Plots

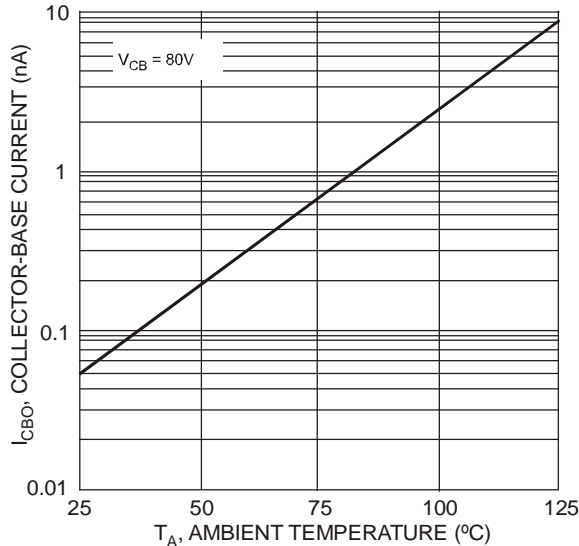

Fig. 8 Typical Collector-Cutoff Current vs. Ambient Temperature

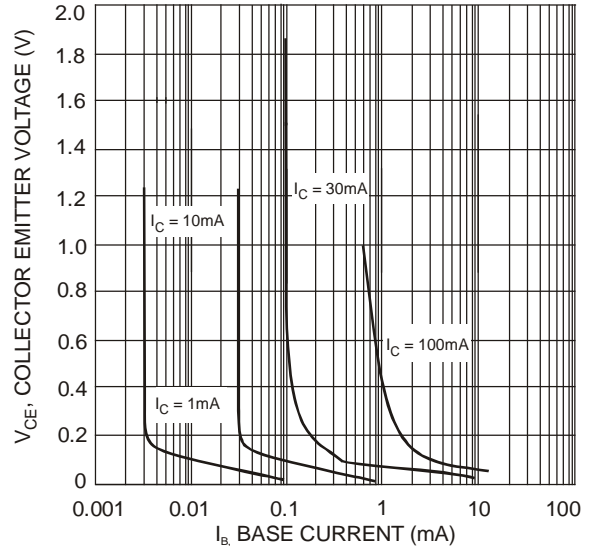

Fig. 9 Typical Collector Saturation Region

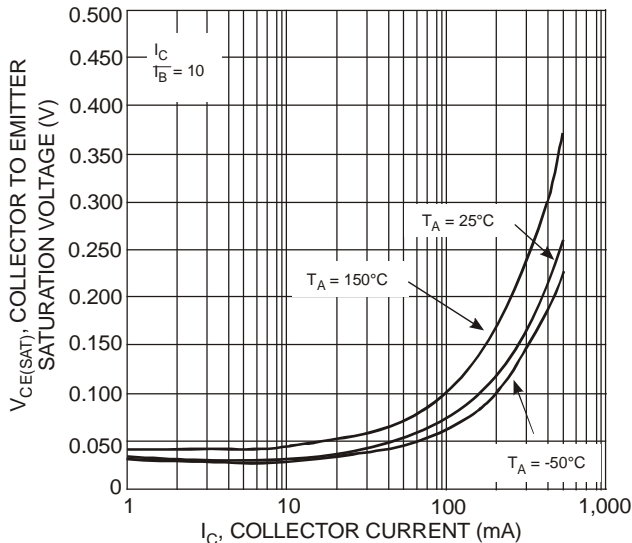

Fig. 10 Typical Collector Emitter Saturation Voltage vs. Collector Current

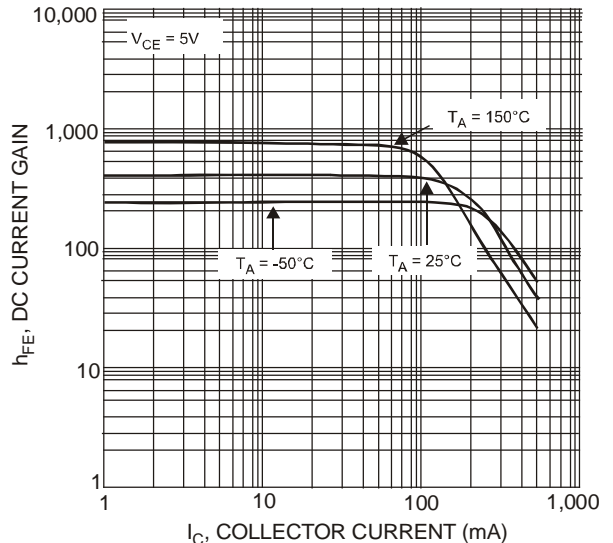

Fig. 11 Typical DC Current Gain vs. Collector Current

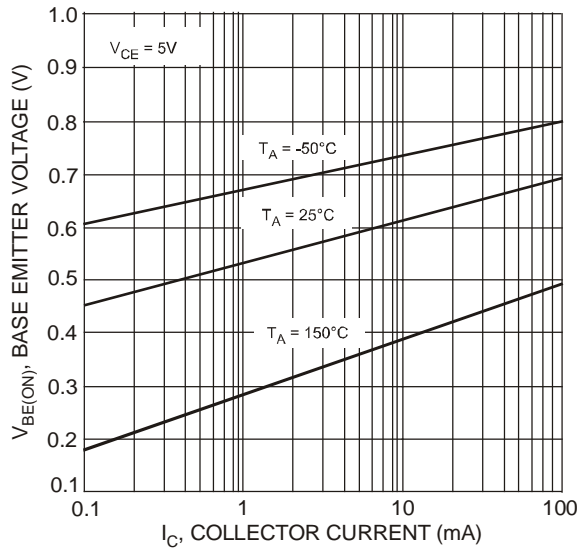

Fig. 12 Typical Base Emitter Voltage vs. Collector Current

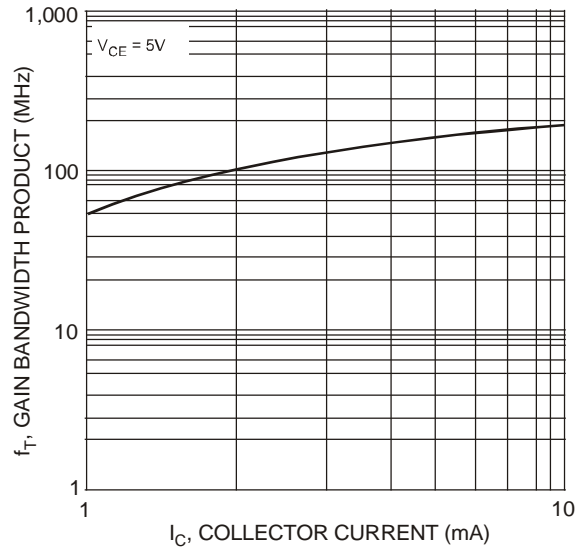
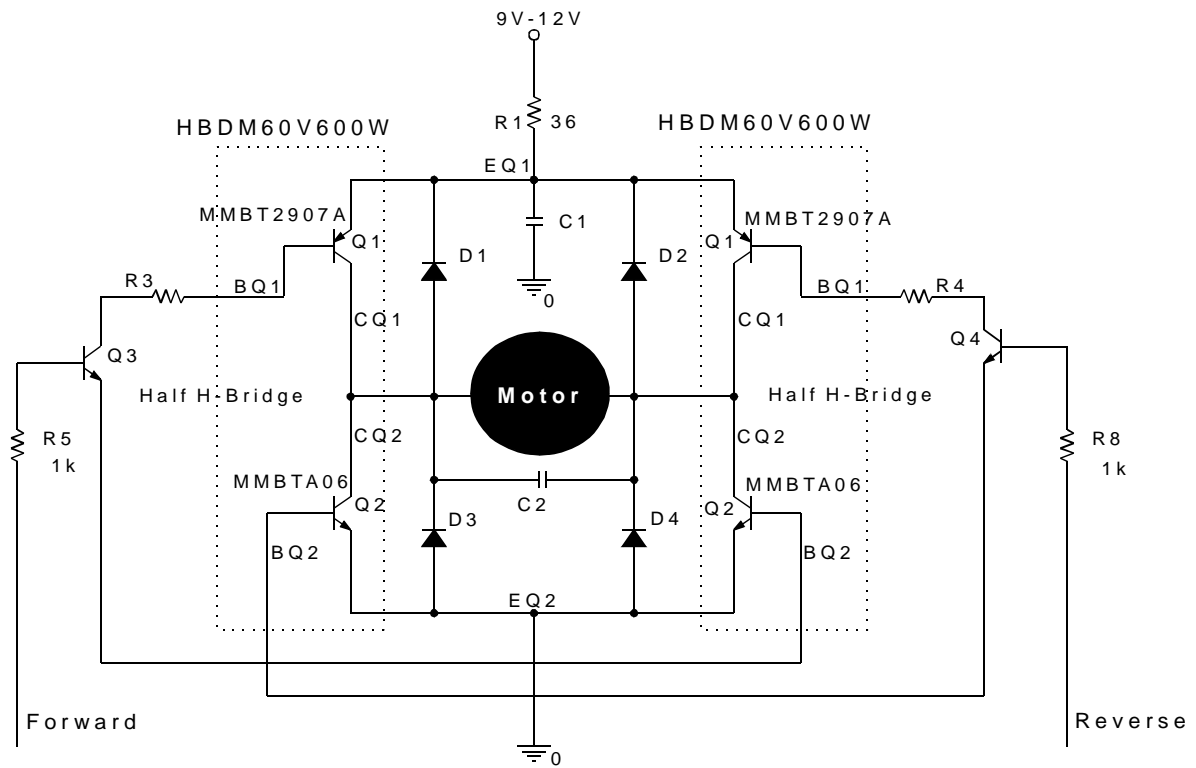

Fig. 13 Typical Gain Bandwidth Product vs. Collector Current

Current Schematic along with Application Example:



Note: D1, D2, D3, D4: Switching Diodes (MMBD4448)
Q3, Q4: NPN Transistors (MMBTA06)

Package Outline Dimensions

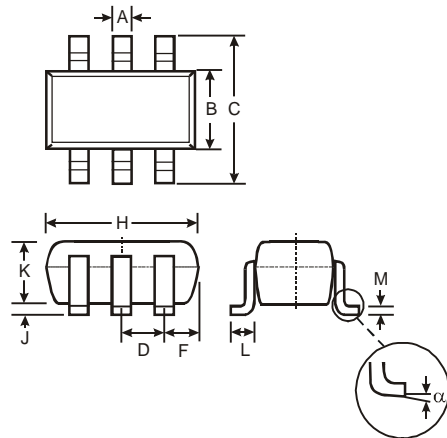

SOT-363		
Dim	Min	Max
A	0.10	0.30
B	1.15	1.35
C	2.00	2.20
D	0.65 Typ	
F	0.40	0.45
H	1.80	2.20
J	0	0.10
K	0.90	1.00
L	0.25	0.40
M	0.10	0.22
α	0°	8°
All Dimensions in mm		

Suggested Pad Layout

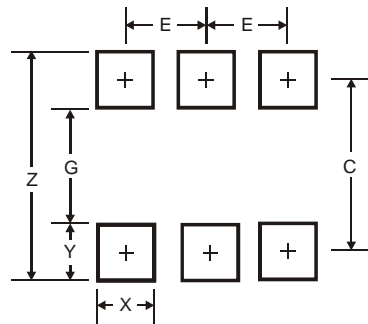

Dimensions	Value (in mm)
Z	2.5
G	1.3
X	0.42
Y	0.6
C	1.9
E	0.65

IMPORTANT NOTICE

Diodes Incorporated and its subsidiaries reserve the right to make modifications, enhancements, improvements, corrections or other changes without further notice to any product herein. Diodes Incorporated does not assume any liability arising out of the application or use of any product described herein; neither does it convey any license under its patent rights, nor the rights of others. The user of products in such applications shall assume all risks of such use and will agree to hold Diodes Incorporated and all the companies whose products are represented on our website, harmless against all damages.

LIFE SUPPORT

Diodes Incorporated products are not authorized for use as critical components in life support devices or systems without the expressed written approval of the President of Diodes Incorporated.